

BRUSS



GREEN skills for enterprises - Sustainable Training for Automotive suppliers cluster



Mestre (Italy) 9 – 10 december 2013

BRUSS

■ Index

Bruss Group

- Locations
- Products
- Customers & Sales

Bruss Durango

- Products
- Customers & Sales
- Components & Processes
- Management system certificates
- Main environmental successes
- Main environmental targets

Introduction of the BRUSS-Group

■ Locations & Co-operations

Foundation 1959

Privately held and owned company
With ~2300 employees



Durango plant Foundation 1967

Currently with ~ 215 employees, the plant was owned along the time by:



Federal Mogul from 1967 to 1989
BRUSS-Federal Mogul from 1989 to 1999
Dichtungstechnik BRUSS from 1999

Product Portfolio

■ Sealing the powertrain through innovation and integration

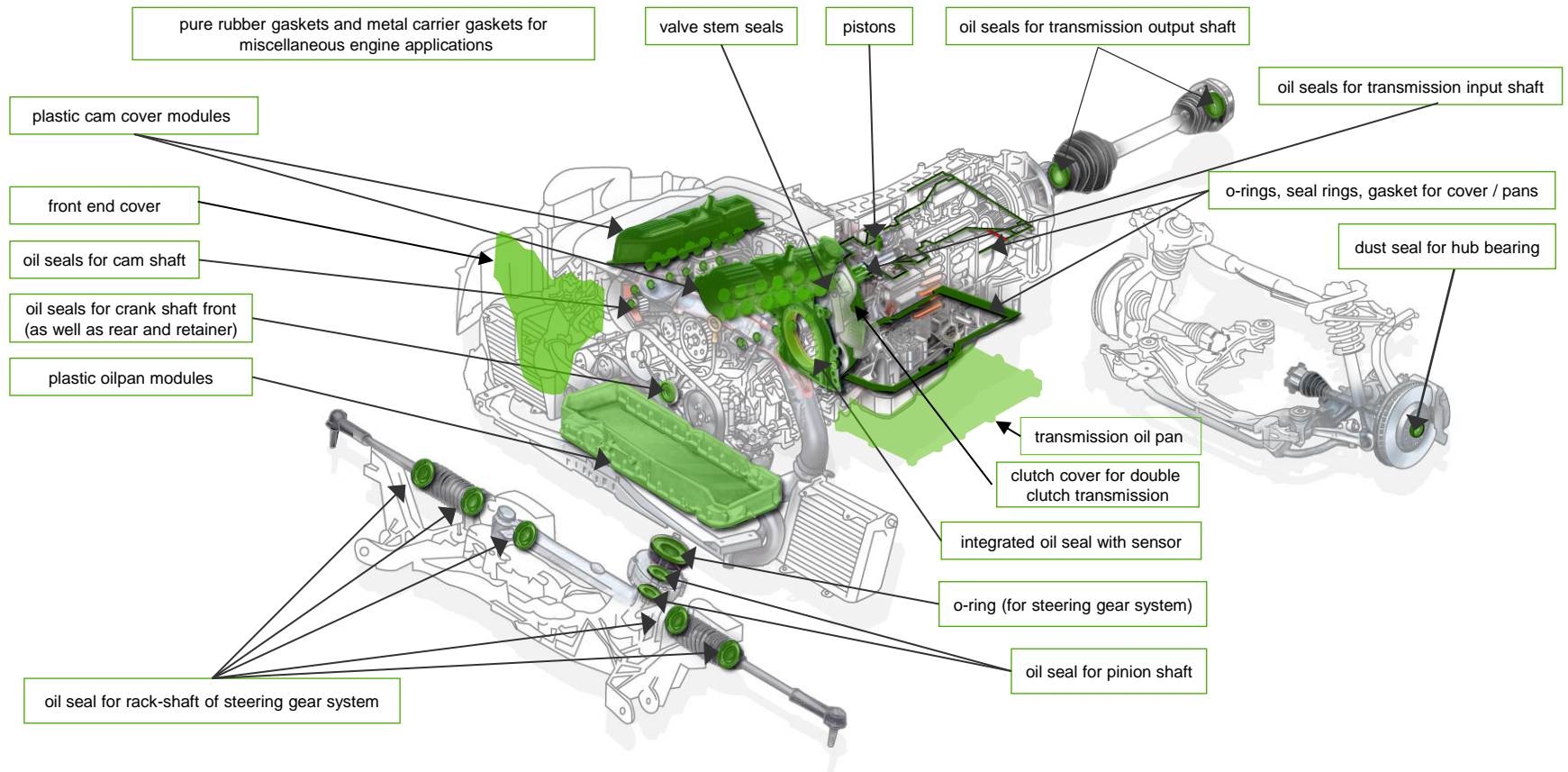



Multiple functions from a single source: our cover modules



BRUSS





Microlip



Cut PTFE



Coined PTFE



F-LESS®



Your complete partner for dynamic sealing systems



BRUSS

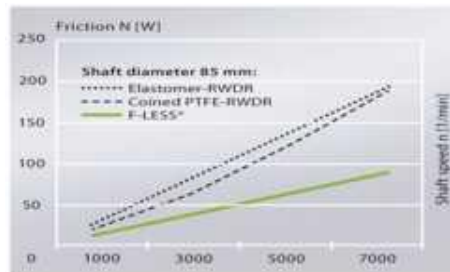



Bonded pistons: the driving force for your transmission



BRUSS

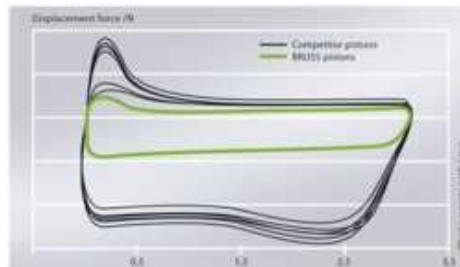



Expertise in elastomer gasket technology

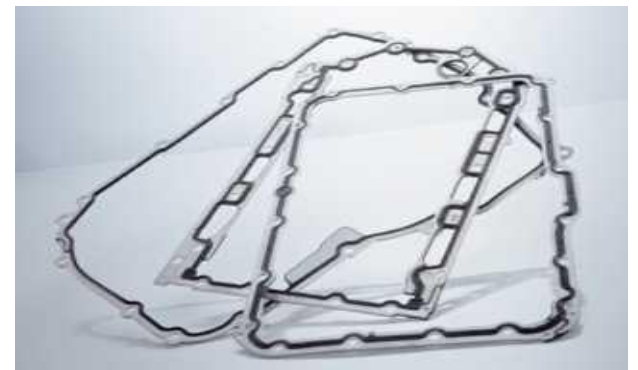

BRUSS

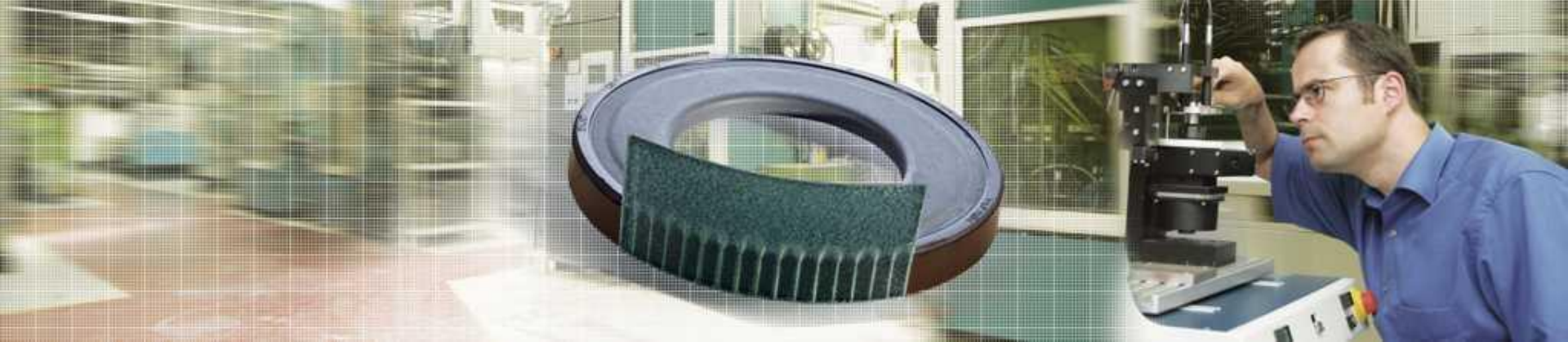

If you want precision: then BRUSS multipole has to be the answer



BRUSS

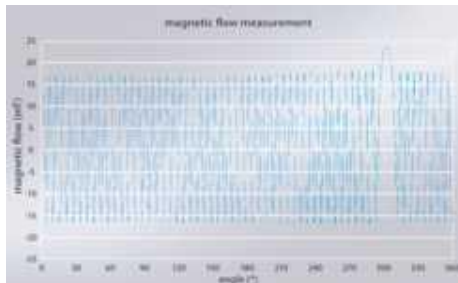

Turnover BRUSS-Group

■ Sales by customers and regions 2012

Sales by customers 2012: 215 Mio €

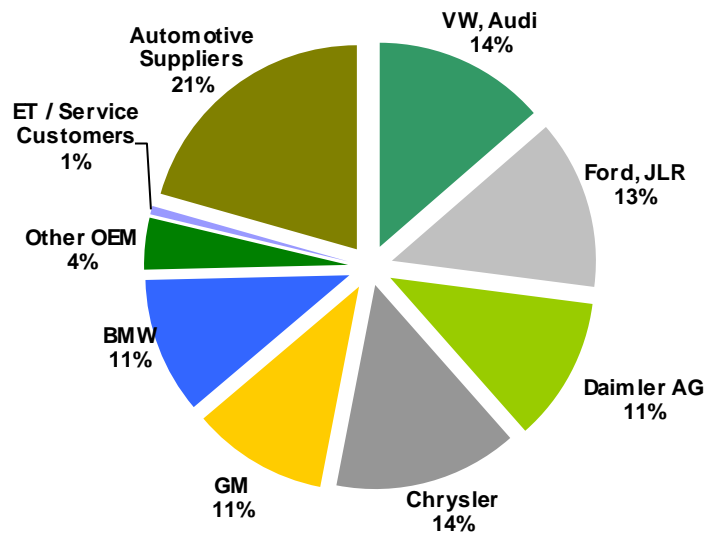

Sales by regions 2012

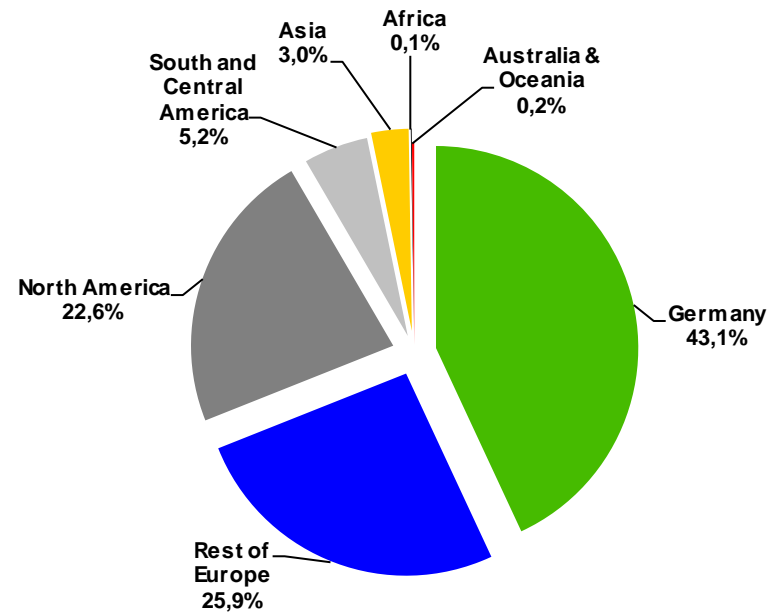

BRUSS plant in Durango / Spain



2012: 197 Employees

BRUSS Juntas Técnicas S. en Com.

Estanislao Labairu, 2

48200 Durango

Spain

Phone: +34 94 621 76-30

Fax: +34 94 621 76-67

E-Mail: BrussEspana@bruss.de

■ Product range

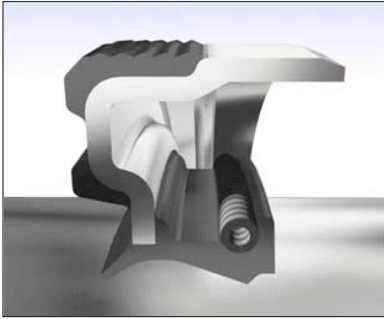

Shaft seals (RWDR)

Sales percentage: 45%

Application: (mainly) **Gear box**

Production technology: **IM** und **CM**

Customers: Ford, Getrag, Daimler, Renault, GM, ...



Cassette seals

Sales percentage: 45%

Application: **Truck axles**

Production technology: **IM** und **CM**

Customers: Schaeffler FAG, M.A.N., Scania, Arvin Meritor, Nissan,

Bonded pistons

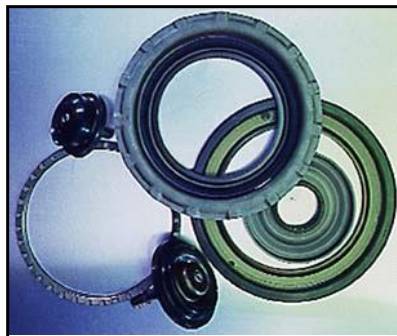

Sales percentage: 10%

Application: **Automatic gear-box**

Production technology: (mainly) **IM**

Customersn: Daimler, Ford, ZF, VW.

Sales development and distribution

Total sales

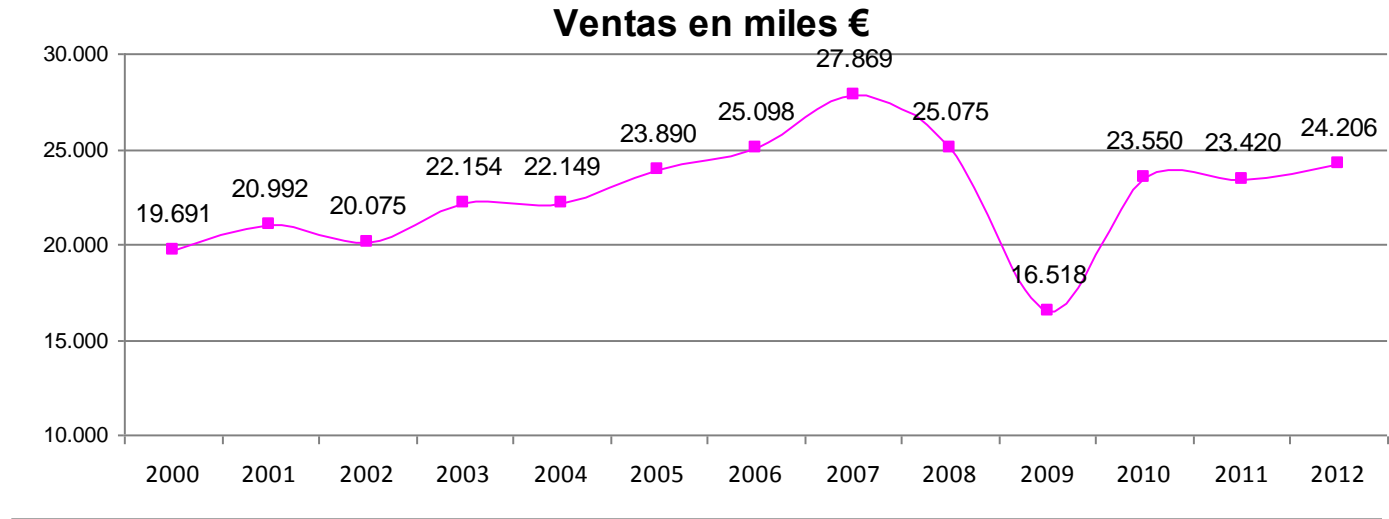

Distribution per customer

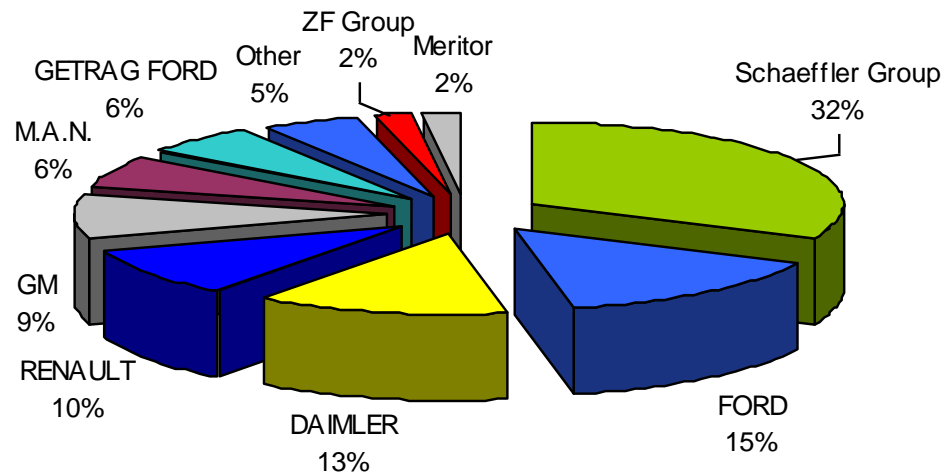

■ Production process

		Materials			
		Stamped Metal case	Rubber	Spring	Packaging material
		Steel	Elastomeric	Steel	Plastic / Cardboard
Process	Material preparation	Degreasing + phoscoating	Preforming	↓	↓
	Moulding process	Vulcanisation in press			
	Postcuring	Post-curing in oven			
	Final and assembly operations	Manual or by automatic machine			
	Packaging	Manual integrated in the manufacturing cells			

■ Management System Certificates

- ISO/TS 16949:2009 valid till March 2015
- ISO 14001:2009 valid till April 2016
(By TÜV Nord Cert. GmbH.)
- Spanish law 31/1995 for H&S at work valid till April 2018
(By Crossber Audit S.L.)

■ Main environmental success

- Substitution of solvent based adhesives by water based adhesives for AEM and FKM products.
- Instalation of a biological treatment for exahust air from painting cabines polluted with solvents
- Installation of a low temperature geothermal system for hot water and climatization purposes.

■ Main environmental targets

- Optimization of rubber waste disposal: From current land-filling to reuse/recycling/valorisation.
Industrial net philosophy according to ZeroWIN European networking project (visit www.zerowin.eu).
- Implication of all the personnel of the company in the development and daily application of the environmental system.

**Thank you very much
for your attention**